

STREAM 51









READY FOR TAKE OFF

Design: Ralf Keferstein

Art.-Nr. / Item-No.
11-945-10-XX

OLIGO Lichttechnik GmbH
Meysstr. 22 - 24
DE - 53773 Hennef
GERMANY
www.oligo.de
info@oligo.de

	12V	max. 50W	Gu 5,3	QR-C 51
(D)	Spannung	Belastung	Fassung	Lampe
(GB)	Voltage	Loading	Fitting	Bulb
(NL)	Spanning	Belasting	Fitting	Verlichtingsmiddel
(F)	Tension	Charge	Douille	Ampoule
(I)	Tensione	Carico	Portalamпада	Sorgente luminosa
(ES)	Tensión	Carga	Portálamparas	Lámpara
(P)	Tensão	Carga	Casquilho	Lâmpada
(DK)	Spænding	Belastning	Fatning	Pære
(S)	Spänning	Belastning	Fatning	Ljuskälla
(N)	Spänning	Fatning	Belastning	Lampe
(FI)	Jännite	Kuormitus	Kanta	Lamppu
(TR)	Gerilim	Yük	Duy	Lamba
(PL)	Napięcie	Oprawka	Obciążenie	Lampa
(GR)	Τάση	Υποδοχή	Φορτίο	Λαμπτήρας
(RUS)	Напряжение	Нагрузка	Патрон	Лампочка
(UAE)	الجهد الكهربى	الدواة	الحمل	المصباح

	
	
	
	
	

MO50737 Ver.9 - 08-16

	12V	max. 50W	Gu 5,3	MR16 SHIELDED
(USA) (CAN)	Voltage/Tension	Loading/Charge	Fitting/Douille	Bulb/Ampoule

	
---	---

A

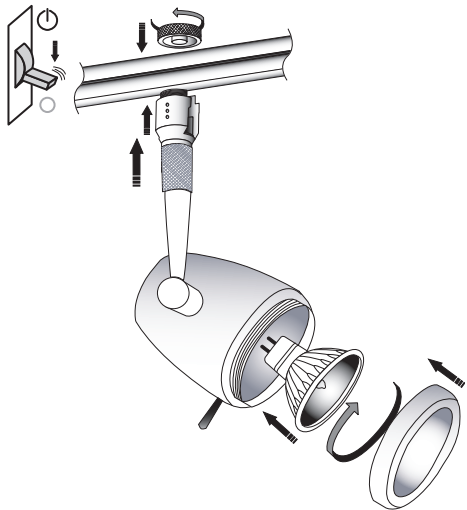

B

