

GATE B SEVEN

CHECK-IN

Design: Raif Keferstein

OLIGO Lichttechnik GmbH

Meysstr. 22 - 24

DE - 53773 Hennef

Germany

www.oligo.de







info@oligo.de

Art.-Nr. / Item-No.

30-973-10-XX (40mm)

30-973-11-XX (110mm)

	max. 250V	max. 50 /75W	GZ 10	Q-PAR51 max.50W Q-PAR64 max.75W
(D)	Spannung	Belastung	Fassung	Lampe
(GB)	Voltage	Loading	Fitting	Bulb
(NL)	Spanning	Belasting	Fitting	Verlichtingsmiddel
(F)	Tension	Charge	Douille	Ampoule
(I)	Tensione	Carico	Portalampada	Sorgente luminosa
(ES)	Tensión	Carga	Portaámparas	Lámpara
(P)	Tensão	Carga	Casquilho	Lâmpada
(DK)	Spænding	Belastning	Fatning	Pære
(S)	Spänning	Belastning	Fattning	Ljuskälla
(N)	Spänning	Fatning	Belastning	Lampe
(FI)	Jännite	Kuormitus	Kanta	Lamppu
(TR)	Gerilim	Yük	Duy	Lamba
(PL)	Napięcie	Oprawka	Obciążenie	Lampa
(GR)	Τάση	Υποδοχή	Φορτίο	Λαμπτήρας
(RUS)	Напряжение	Нагрузка	Патрон	Лампочка
(JAE)	الجهد الكهربى	الدواة	الحمل	المصباح

	
	
LED READY	
CE	

A

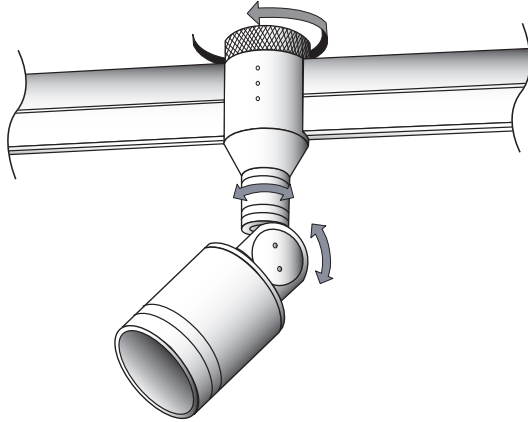

B

